

表面

QFP100pin/0.5pitch

裏面

QFP100pin/0.65pitch

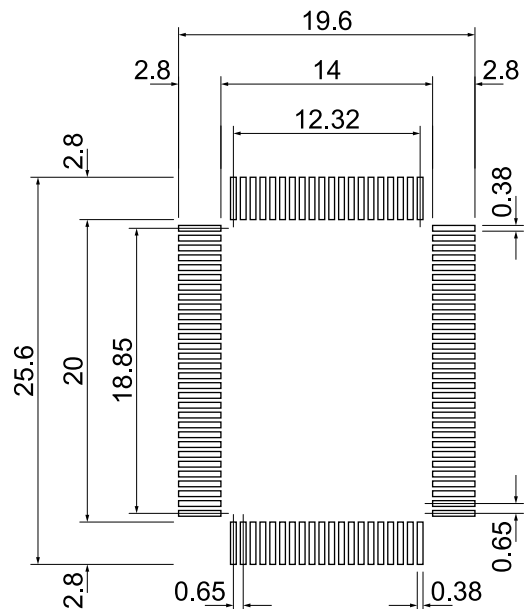
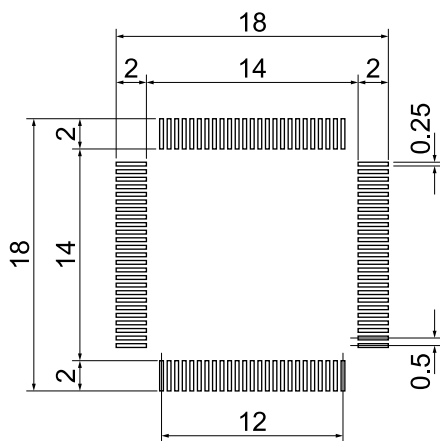
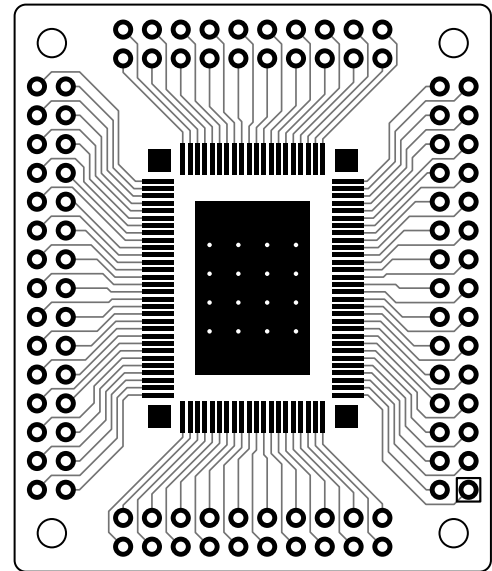
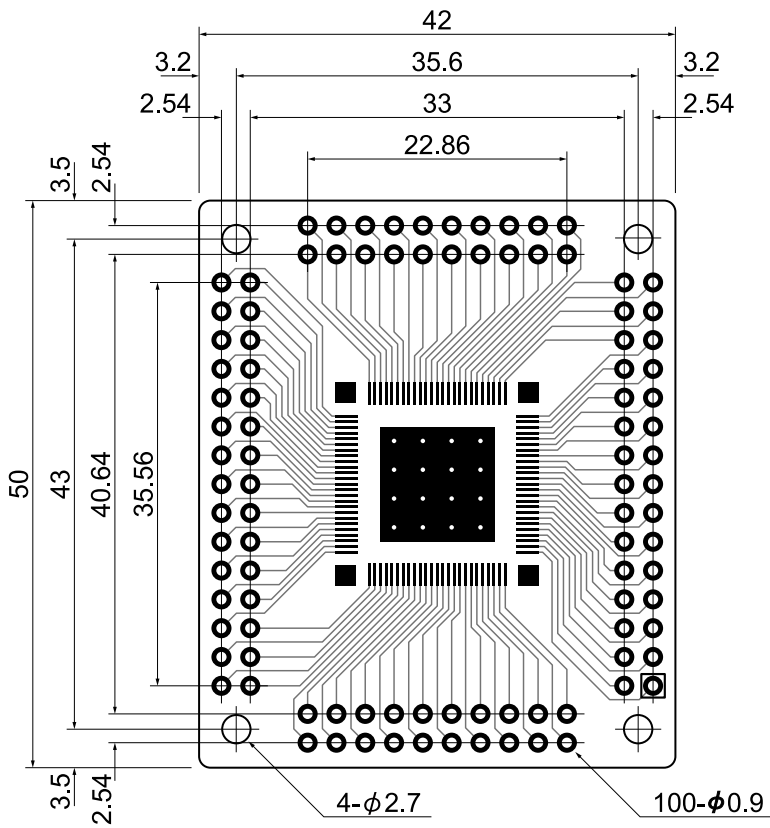

品名	QFP変換基板			図番	080905-04	縮尺	----
型名	Q100	材質	FR-4	作成日	2008-09-05		
寸法	42 x 50 mm	板厚	1.0t	株式会社ダイセン電子工業 https://www.daisendenshi.com/			
処理	金メッキ / 両面スルー						