

表面

QFP80pin/0.5pitch

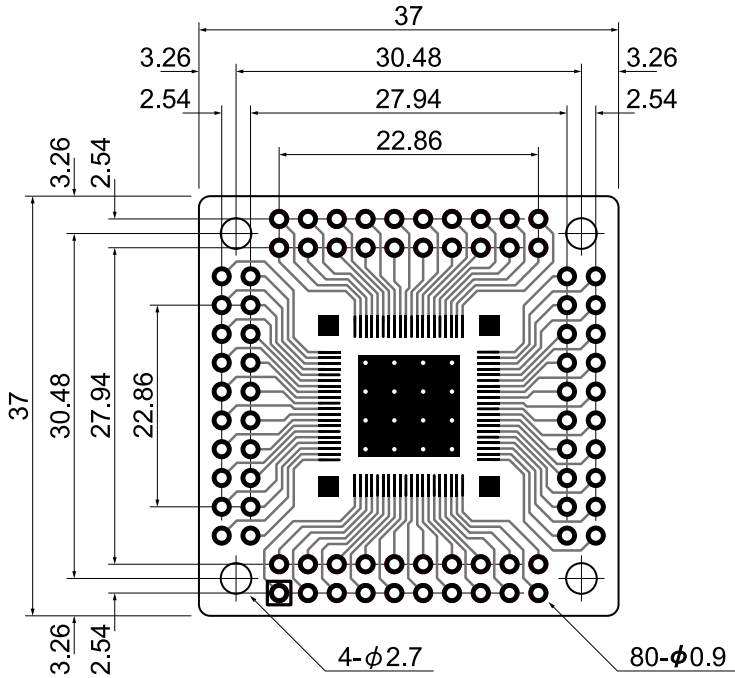

裏面

QFP80pin/0.65pitch

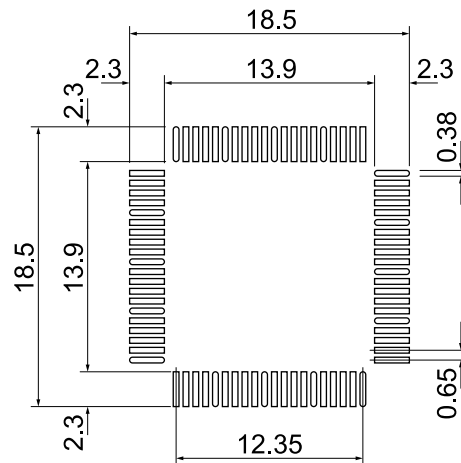
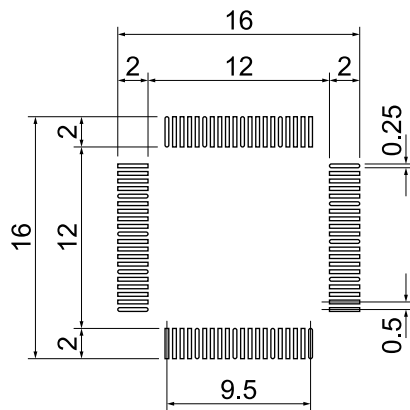
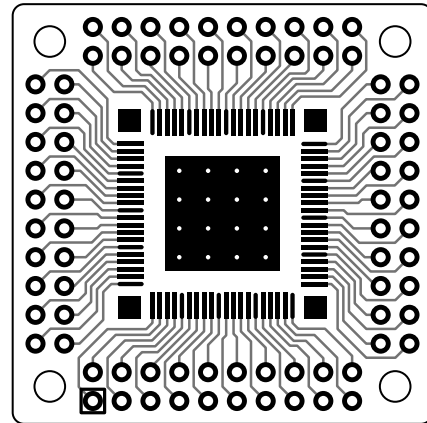

品名	QFP変換基板			図番	080905-03	縮尺	----
型名	Q080	材質	FR-4	作成日	2008-09-05		
寸法	37 x 37 mm	板厚	1.0t	株式会社ダイセン電子工業 https://www.daisendenshi.com/			
処理	金メッキ/両面スルー						